

MC1590G

ELECTRICAL CHARACTERISTICS ($V_{CC} = +12$ Vdc, $f = 60$ MHz, BW = 1.0 MHz, $T_A = -55^\circ\text{C}$ to $+125^\circ\text{C}$ unless otherwise noted)

Characteristic	Fig.	Symbol	Min	Typ	Max	Unit
AGC Range ($V_2(\text{AGC}) = 5.0$ V to 7.0 V) ($V_2(\text{AGC}) = 5.0$ V to 7.0 V, $T_A = 25^\circ\text{C}$)	24	M_{AGC}	58 60	— 88	— —	dB
Single-Ended Power Gain ($T_A = 25^\circ\text{C}$)	24	G_p	37 40	— 45	— —	dB
Noise Figure (R_S optimized for best NF) ($T_A = 25^\circ\text{C}$)	24	NF	—	6.0	7.0	dB
Output Stage Current (Sum of Pins 5 and 6) ($T_A = 25^\circ\text{C}$)	32	I_O	3.5 4.0	— 5.6	8.0 7.5	mA
Output Current Matching (Magnitude of Difference of Output Currents) ($I_5 - I_6$) ($T_A = 25^\circ\text{C}$)	32	ΔI_O	—	0.7	—	mA
Power Supply Current ($V_O = 0$ V) ($V_O = 0$ V, $T_A = 25^\circ\text{C}$)	32	I_{CC}	— —	— 14	20 17	mA
Power Consumption ($12 \times I_{CC}$) ($V_I = 0$ V) ($V_I = 0$ V, $T_A = 25^\circ\text{C}$)	—	P_C	— —	— 168	240 204	mW

2

FIGURE 1 – UNNEUTRALIZED POWER GAIN versus FREQUENCY
(Tuned Amplifier, See Figure 24)

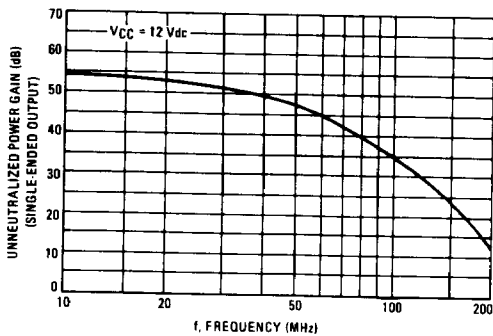
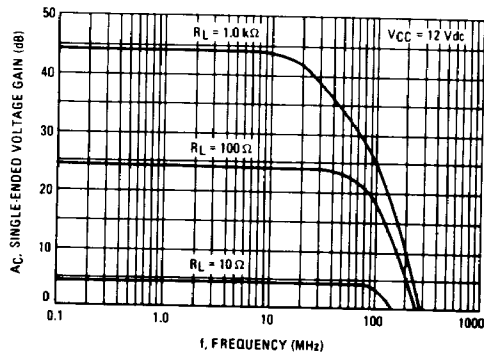

FIGURE 2 – VOLTAGE GAIN versus FREQUENCY
(Video Amplifier, See Figure 26)



MC1590G

TYPICAL CHARACTERISTICS

($V_2(AGC) = 0$, $V_{CC} = 12$ Vdc, $T_A = +25^\circ\text{C}$ unless otherwise noted)

FIGURE 3 – DYNAMIC RANGE: OUTPUT VOLTAGE versus INPUT VOLTAGE (Video Amplifier, See Figure 26)

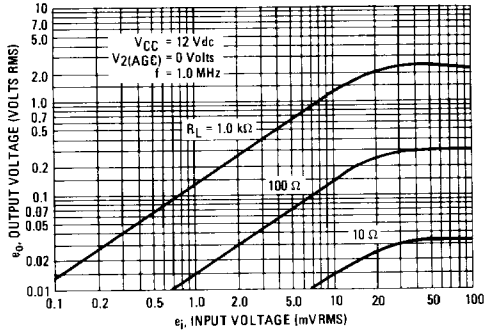

FIGURE 4 – VOLTAGE GAIN versus FREQUENCY (Video Amplifier, See Figure 26)

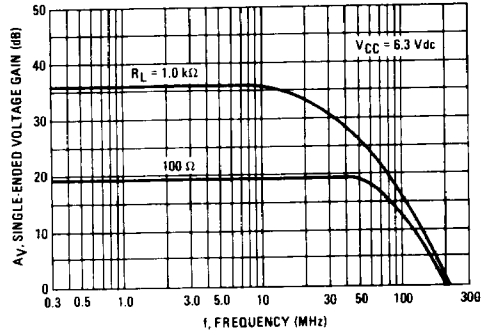

FIGURE 5 – VOLTAGE GAIN AND SUPPLY CURRENT versus SUPPLY VOLTAGE (Video Amplifier, See Figure 26)

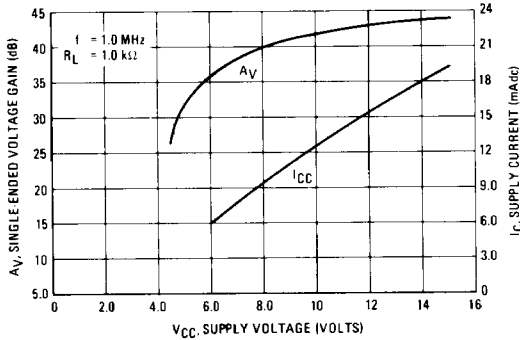

FIGURE 6 – TYPICAL GAIN REDUCTION versus AGC VOLTAGE

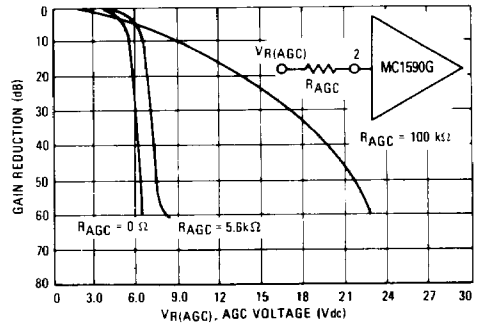

FIGURE 7 – TYPICAL GAIN REDUCTION versus AGC CURRENT

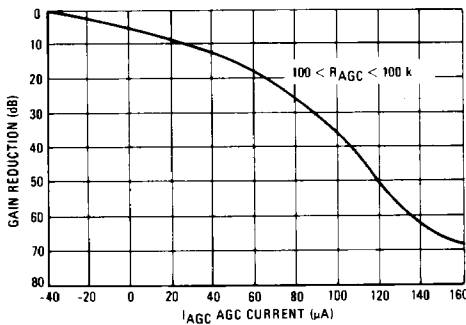
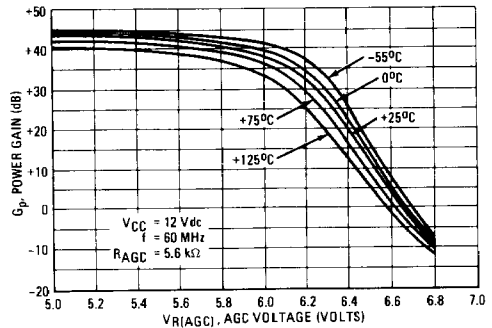

FIGURE 8 – FIXED TUNED POWER GAIN REDUCTION versus TEMPERATURE (See Test Circuit, Figure 24)



TYPICAL CHARACTERISTICS (continued)

FIGURE 9 – POWER GAIN versus SUPPLY VOLTAGE
(See Test Circuit, Figure 24)

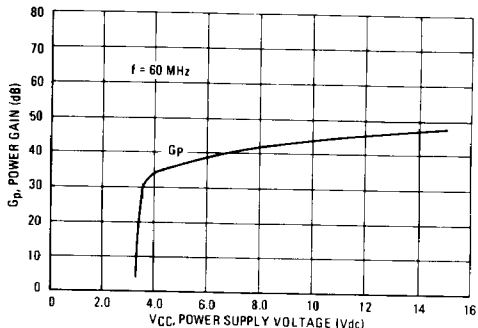

FIGURE 10 – REVERSE TRANSFER ADMITTANCE versus FREQUENCY
(See Parameter Table, Page 1)

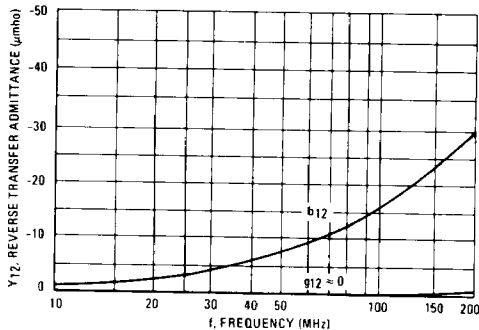

FIGURE 11 – NOISE FIGURE versus FREQUENCY

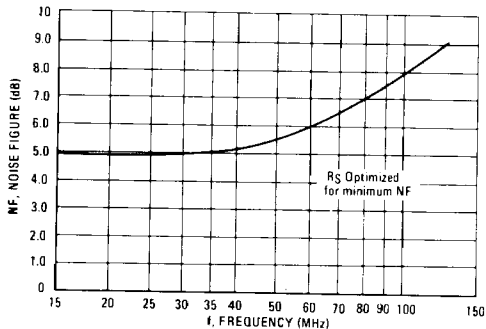

FIGURE 12 – NOISE FIGURE versus SOURCE RESISTANCE

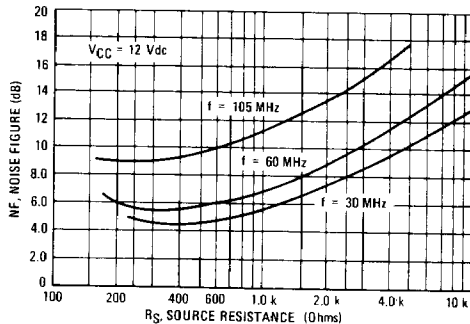
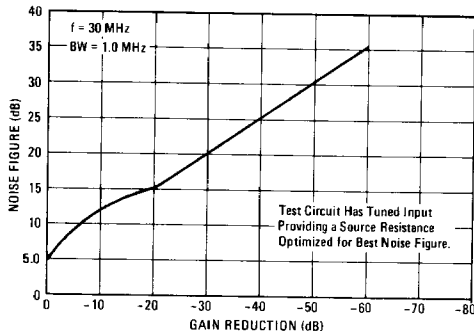

FIGURE 13 – NOISE FIGURE versus AGC GAIN REDUCTION



MC1590G

TYPICAL CHARACTERISTICS (continued)

FIGURE 14 — SINGLE-ENDED OUTPUT ADMITTANCE

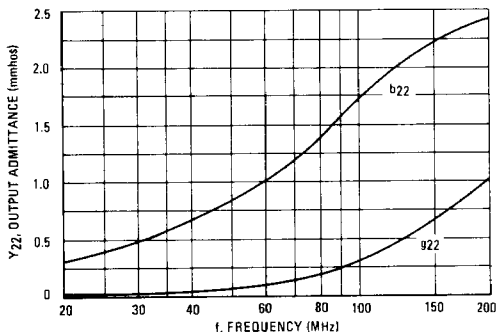

FIGURE 15 — SINGLE-ENDED INPUT ADMITTANCE

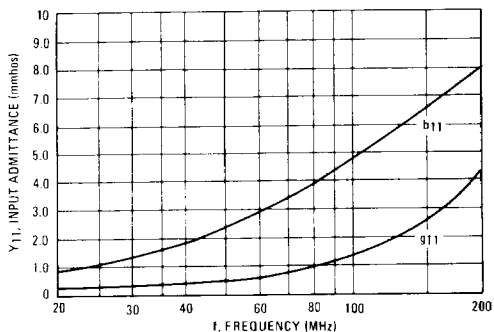

FIGURE 16 — HARMONIC DISTORTION versus AGC GAIN REDUCTION FOR AM CARRIER (For Test Circuit, See Figure 17)

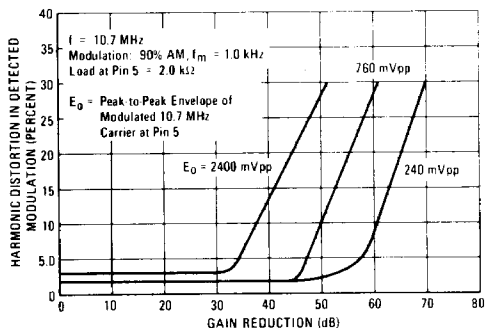

FIGURE 17 — 10.7 MHz AMPLIFIER

Gain = 55 dB, BW = 100 kHz

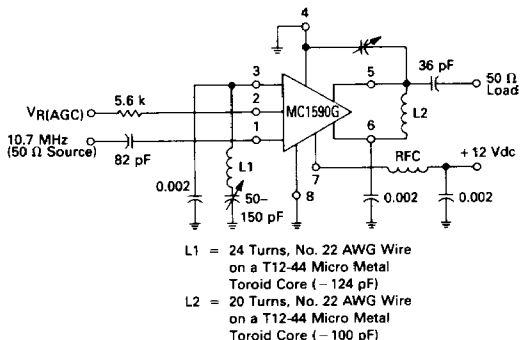

FIGURE 18 — Y_{21} , FORWARD TRANSFER ADMITTANCE RECTANGULAR FORM

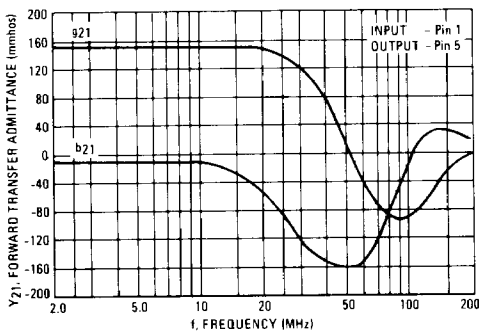
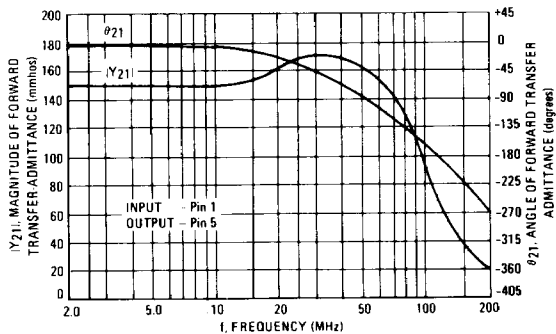

FIGURE 19 — Y_{21} , FORWARD TRANSFER ADMITTANCE POLAR FORM



TYPICAL CHARACTERISTICS (continued)

FIGURE 20 – S_{11} AND S_{22} , INPUT AND OUTPUT REFLECTION COEFFICIENT

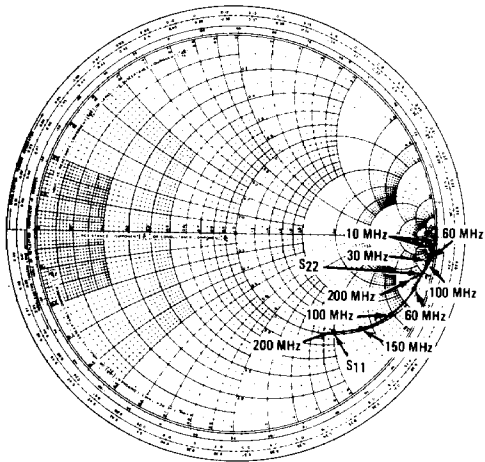

FIGURE 21 – S_{11} AND S_{22} , INPUT AND OUTPUT REFLECTION COEFFICIENT

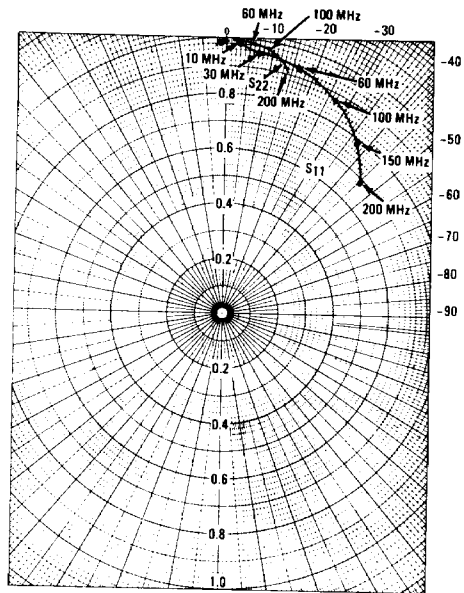

FIGURE 22 – S_{21} , FORWARD TRANSMISSION COEFFICIENT (GAIN)

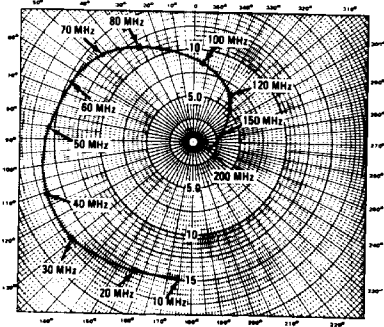
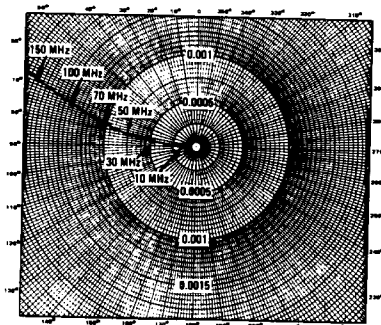

FIGURE 23 – S_{12} , REVERSE TRANSMISSION COEFFICIENT (FEEDBACK)



MC1590G

TYPICAL APPLICATIONS

FIGURE 24 — 60 MHz POWER GAIN TEST CIRCUIT

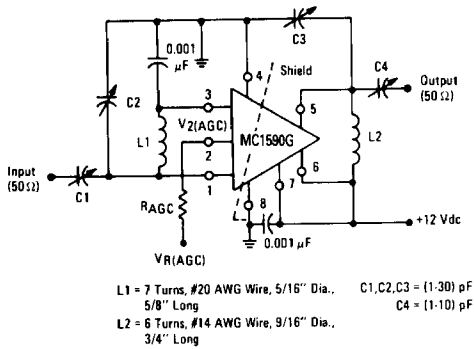
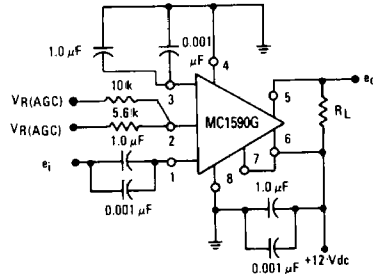

FIGURE 25 — PROCEDURE FOR SETUP USING FIGURE 24

Test	e_{in}	$V_2(AGC)$	$R_{AGC}(k\Omega)$
MAGC	2.23 mV (-40dBm)	5.7 V	0
Gp	1.0 mV (-47dBm)	≤ 5.0 V	5.6
NF	1.0 mV (-47dBm)	≤ 5.0 V	5.6

FIGURE 26 — VIDEO AMPLIFIER



**FIGURE 27 — 30 MHz AMPLIFIER
(Power Gain = 50 dB, BW = 1.0 MHz)**

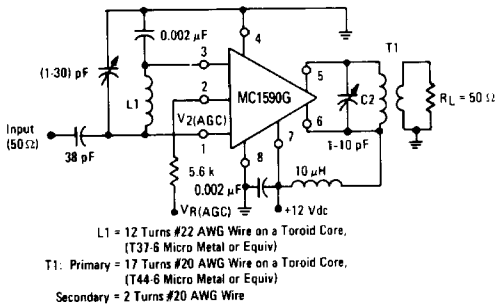

FIGURE 28 — 100 MHz MIXER

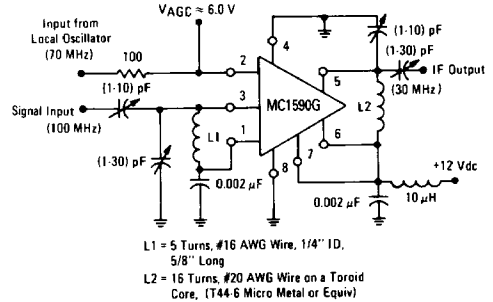
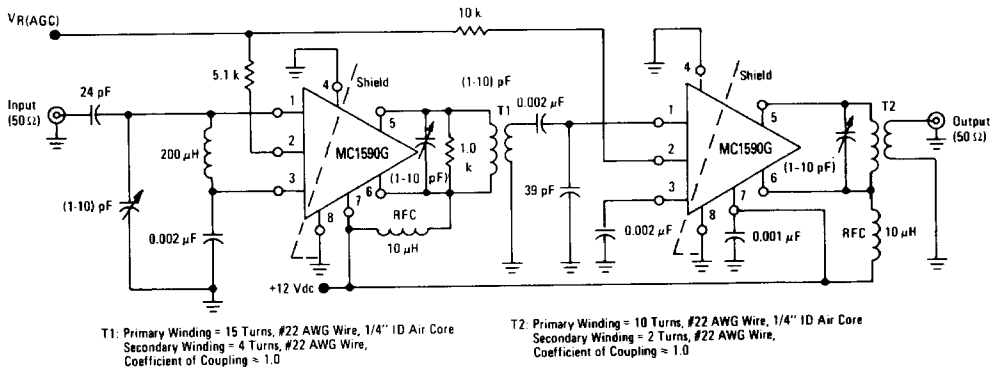
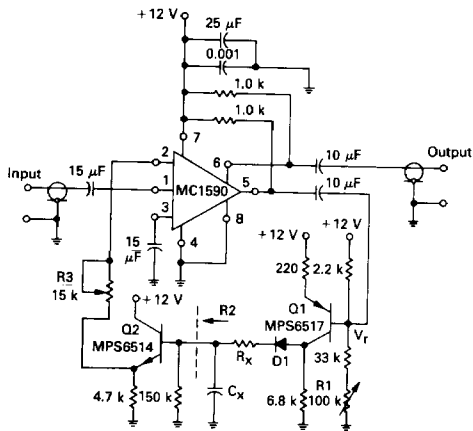

FIGURE 29 — TWO-STAGE 60 MHz IF AMPLIFIER (Power Gain ≈ 80 dB, BW ≈ 1.5 MHz)



TYPICAL APPLICATIONS (continued)

FIGURE 30 – SPEECH COMPRESSOR



DESCRIPTION OF SPEECH COMPRESSOR

The amplifier drives the base of a PNP MPS6517 operating common-emitter with a voltage gain of approximately 20. The control R1 varies the quiescent Q point of this transistor so that varying amounts of signal exceed the level V_r . Diode D1 rectifies the positive peaks of Q1's output only when these peaks are greater than $V_r \approx 7.0$ Volts. The resulting output is filtered by C_x , R_x .

R_x controls the charging time constant or attack time. C_x is involved in both charge and discharge. R2 (the 150 kΩ and input resistance of the emitter-follower Q2) controls the decay time. Making the decay long and attack short is accomplished by making R_x small and R2 large. (A Darlington emitter-follower may be needed if extremely slow decay times are required.)

The emitter-follower Q2 drives the AGC Pin 2 of the MC1590G and reduces the gain. R3 controls the slope of signal compression. The following graph (Figure 31) details performance with R3 set to 15 kΩ.

FIGURE 31 – OUTPUT VOLTAGE versus INPUT VOLTAGE

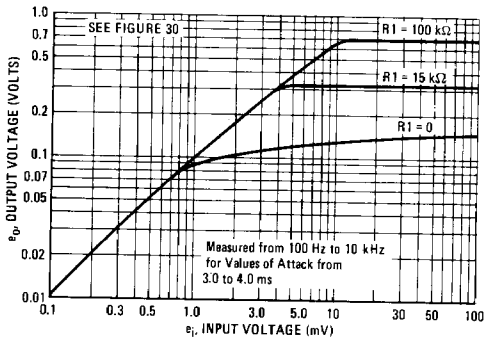

TABLE 1 — DISTORTION versus FREQUENCY

FREQUENCY	DISTORTION		DISTORTION	
	10 mV e_i	100 mV e_i	10 mV e_i	100 mV e_i
100 Hz	3.5%	12%	15%	27%
300 Hz	2%	10%	6%	20%
1.0 kHz	1.5%	8%	3%	9%
10 kHz	1.5%	8%	1%	3%
100 kHz	1.5%	8%	1%	3%

- Notes 1 and 2
- Notes 3 and 4
- Note: (1) Decay = 300 ms
Attack = 20 ms
- (2) $C_x = 7.5 \mu\text{F}$
 $R_x = 0$ (Short)
- (3) Decay = 20 ms
Attack = 3 ms
- (4) $C_x = 0.68 \mu\text{F}$
 $R_x = 1.5 \text{ k}\Omega$

FIGURE 32 – OUTPUT CURRENT, CURRENT MATCH AND I_{CC} FIXTURE

